

Choosing and Using Pyroelectric Detectors

By

Hans Keller & David Cima
ELTEC Instruments, Inc.



ELTEC INSTRUMENTS, INC.

Pyroelectrics are Sensitive

Pyroelectrics are "thermal" sensors wherein optical power is converted to an electrical output. They can provide up to four orders of magnitude higher output signals (responsivity) than thermistors or thermopiles, making the pyroelectric much easier to interface with a measurement or control circuit. Moreover, the pyroelectric responds only to a change in radiation intensity. And it is easier detecting a change than discriminating a small shift in levels.

Since the pyroelectric is a thermal detector, its response is independent of the wavelength of radiant energy it receives — a fact that makes the device useful anywhere in the spectrum between and including soft X-rays to the far infrared. The pyroelectric detector is especially practical for the mid to far infrared because of its high sensitivity without the need for cooling.

The 3 Selection Decisions

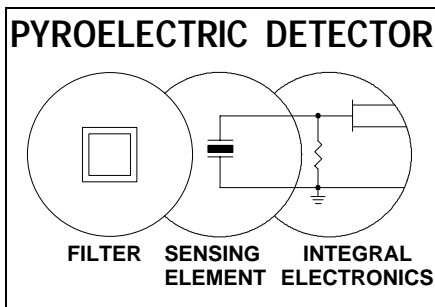

A detector consists of a **filter**, a **sensing element**, and **integral electronics**. The filter restricts incoming radiation to a wavelength band of interest, the crystal responds to the incident energy and produces a signal, and the integral electronics assist in mating the signal with other equipment. ELTEC makes available a variety of filters, crystals, and electronics so as to best meet the needs

of specific applications. ELTEC detectors are also available without electronics.

1. Selecting The Filter

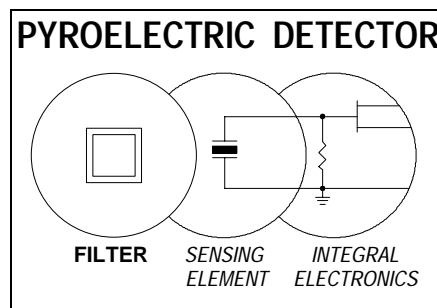

The filter protects the crystal and internal electronics from physical damage and moisture. The filter, when properly selected, will block wavelengths of no interest and pass those desired.

The key to filter selection is to determine what you are looking at and what might interfere.

If you are looking at an object, check the black-body chart for wavelength distribution at the object's temperature. Thus, if you desire to sense the presence of a

person, only those wavelengths near 10 micrometers carry significant energy. Possible sources of interference are the sun (reflected from automobile chrome or windshields ... even coming from behind clouds), incandescent lights and headlights. Since the wavelengths of maximum energy for the sun and incandescent lights are much shorter than those for a person, a "long-pass" filter - like ELTEC's HP-7 (-3) (6.5 - 14 micrometers) filter will be quite discriminating. The colder a body, the longer the wavelengths and lower the energy - which is to say there "generally" is little need to attenuate the wavelengths on the long side of the band of interest unless there is a monochromatic source (a laser) or a nearby longer wavelength object or intense object with wavelength spillover into the longer bands.

Working with gases, as in a flame flicker at the carbon dioxide absorption wavelength of 4.35 micrometers, a very restrictive "bandpass" filter may be required. Otherwise, using the wavelength of maximum energy will be the most practical guide. The simplified form of Wien's Displacement Law gives the max-energy wavelength (λ) in micrometers: $=2893/T$, where T is in Kelvin degrees (C + 273).

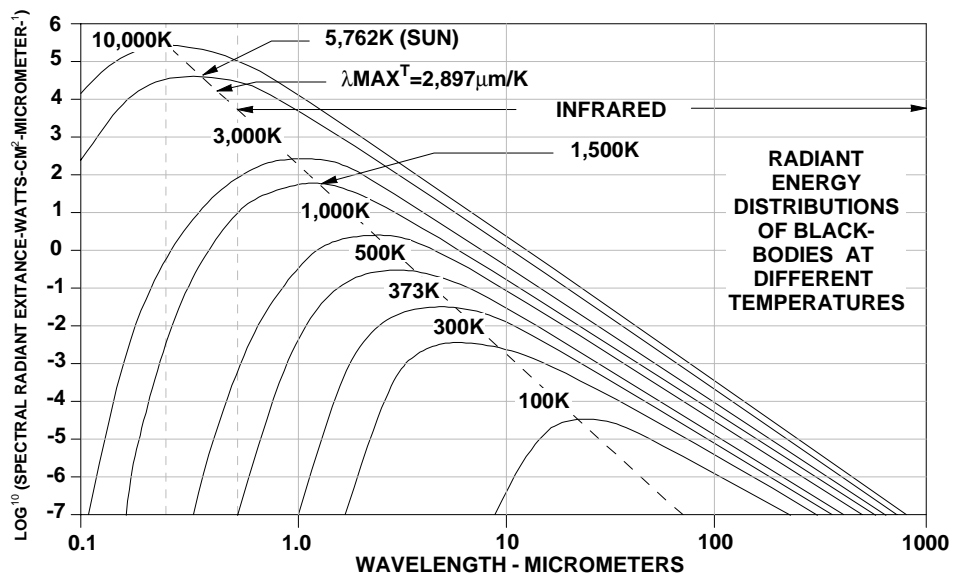

The filter table and graphs show the transmittance of many practical filter materials and their ELTEC ordering numbers (-n). Other materials or specially coated filters can be ordered. When investigating special filters, make sure the material is compatible with your environment (e.g., crystalline salt is an extremely

good IR material - as long as it doesn't get wet). And examine the cost-effectiveness as well — for diamond has many desirable properties in the infrared.

Contact ELTEC for specifications of individual filters.

People, Objects and ELTEC's High Pass (HP7) Coated Filter (-3) and the Atmospheric Filter (-25)

ELTEC's HP7 (-3) filter is most popular because it blocks the shorter wavelengths from the sun and incandescent lights yet gives high transmittance to the band of greatest energies emitted by people. This filter is also chosen for radiometric and industrial control applications. ELTEC's -25 filter is similar to the HP7 except that the response is more closely tailored to the "atmospheric region" of from 8 to 14 micrometers (a region where the normal constituents of the atmosphere do not seriously interfere with the transmission of infrared radiation). By not including the 7 micrometer chunk of the spectrum, difficulties from atmospheric moisture can be minimized. Both the -3 and -25 filters have semiconductor substrates and are electrically connected to the detector case for electrostatic shielding.

Germanium (Uncoated)(-1)

An excellent IR material with flat transmittance from 2 to 25 micrometers. Its high index of refraction (greater than 4) produces a high reflection loss and thus a transmittance of slightly less than 50% in the thickness used for filters. Germanium is a semiconductor and ELTEC bonds it to the detector case for added electrostatic shielding. Note: Germanium also has transmittance from 40 to beyond 300 micrometers.

Germanium (Anti-reflection coated 10.6 μm)(-2)

A much higher transmittance than uncoated germanium, but not a flat response. However, the transmittance is optimized for 10.6 carbon dioxide lasers. It is also high in the bandwidth of room temperature objects and for work in the "atmospheric window" of 8 to 14 micrometers. The semiconductor filter affords electrostatic shielding.

Silicon (-5)

An excellent infrared bandpass material because it has good chemical resistance and high resistance to thermal shock. There is usually a strong absorption band at 9 micrometers ... and then transmittance into the far infrared. Actual transmittance varies with the purity of the silicon. Although silicon does not pass visible light, it can transmit enough near-IR to affect photosensitive transistors on detectors. As a semiconductor, silicon affords electrostatic shielding. Note that this filter does not have an anti-reflection coating and thus has transmission less than 50%. Also see the -32 filter.

NARROWBAND FILTERS

CWL (μm)	ELTEC Filter #	HBW (μm)	Substrate Material	Peak Transmission
3.33	-336	.145	QUARTZ	>= 70% PEAK
3.43	-55	.14	QUARTZ	>= 75% PEAK ¹
3.80	-380	.18	SAPPHIRE	>= 72% PEAK
4.260	-442	.195	SAPPHIRE	>= 75% PEAK
4.268	-113	.17	SAPPHIRE	>= 75% PEAK
4.30	-43	.10	SAPPHIRE	>= 75% PEAK
4.45	-79	.156	SILICON	>= 70% PEAK
4.740	-540	.140	SAPPHIRE	>= 75% PEAK
8.4	-464	.250	GERMANIUM	>= 70% PEAK
9.2	-463	.250	GERMANIUM	>= 70% PEAK

NOTE: EXCEPT WHERE NOTED, FILTER TABLE AND GRAPHICAL REPRESENTATIONS ARE SUBJECT TO VARIATIONS. THE USER MUST CONSIDER WHAT EFFECT THESE VARIATIONS AND TOLERANCES WILL HAVE ON THE USER'S APPLICATION. CONTACT ELTEC FOR SPECIFICATIONS OF INDIVIDUAL FILTERS.

¹ MEASURED AT 12 DEGREE ANGLE OF INCIDENCE

ATMOSPHERIC FILTERS

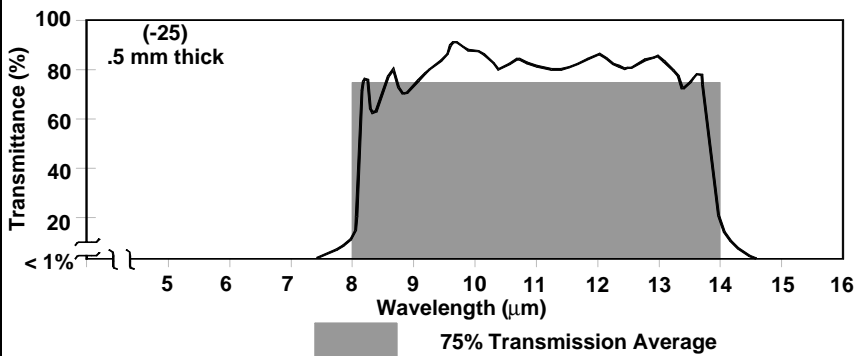
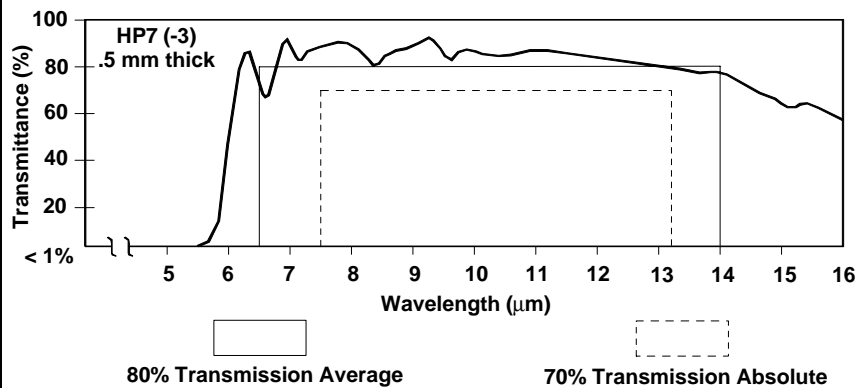

TRANSMITTANCE OF FILTERS & AR COATED MATERIALS

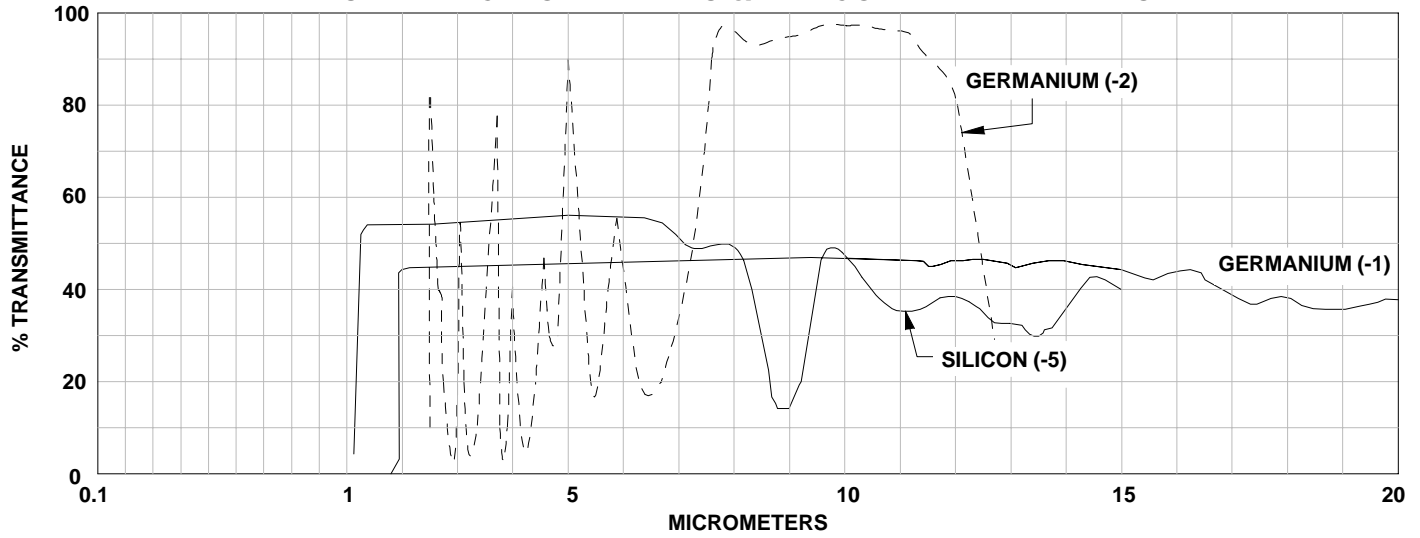

TRANSMITTANCE OF UNCOATED FILTERS & AR COATED MATERIALS

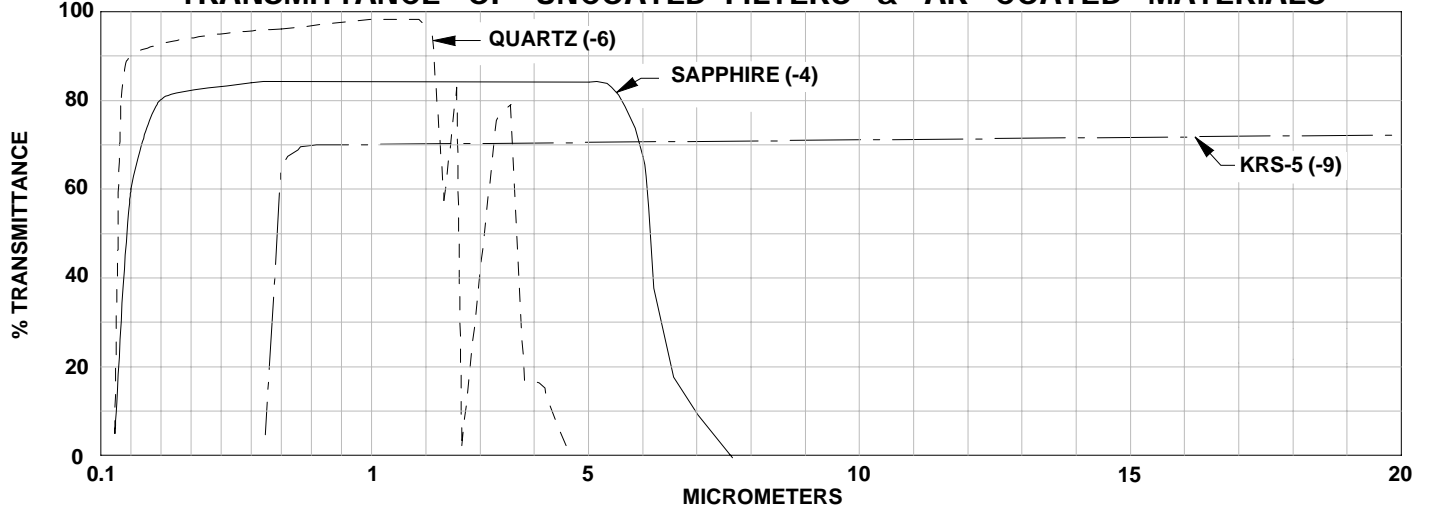

FIRE FILTERS

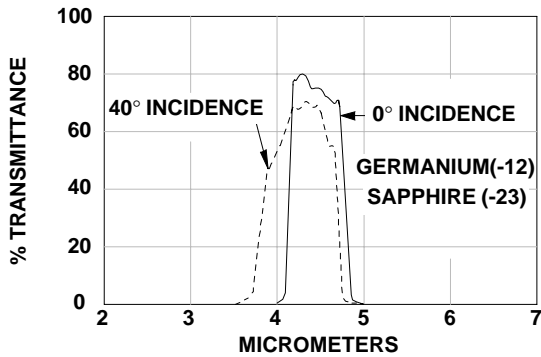

BROADBAND (-32) SILICON

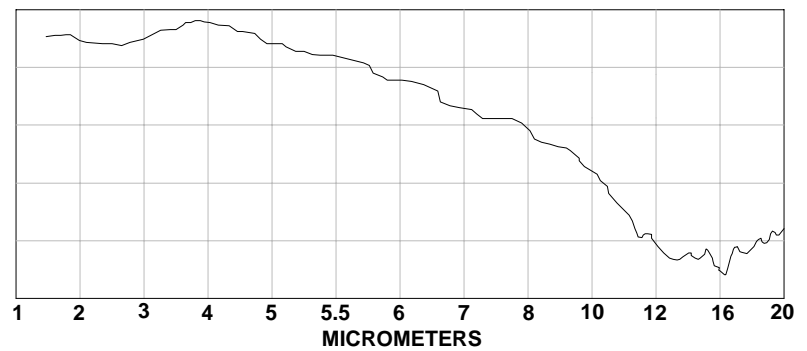

CALCIUM FLUORIDE (-27); BARIUM FLUORIDE (-42); ZINC SELENIDE (-49)

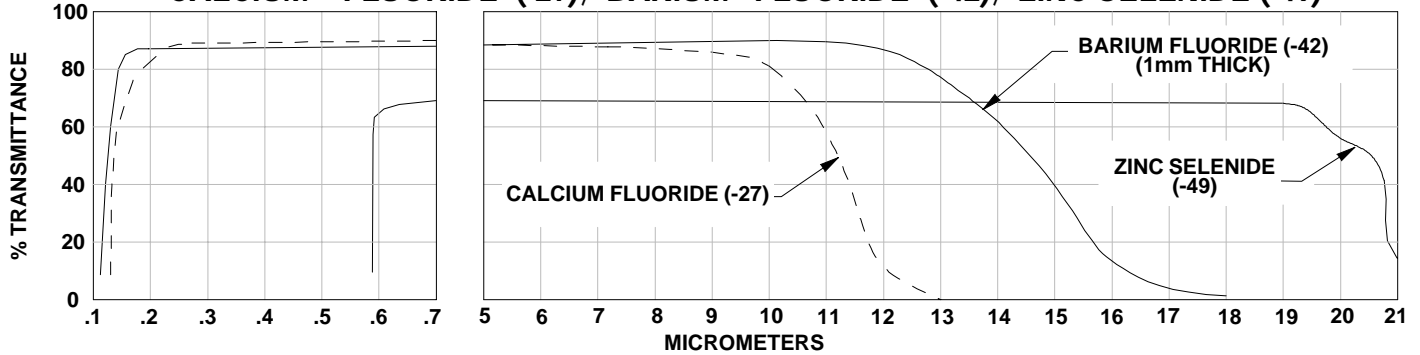

Ultraviolet Grade Fused Quartz (-6)

A high transmission passband from ultraviolet to about 2 micrometers. Since it passes visible light, it must be used with a detector with encapsulated electronics or with a light barrier between the electronics and the filter. Quartz has excellent chemical resistance. Note: Quartz "turns on" again at about 100 micrometers and has high transmittance in the far infrared.

Sapphire (-4)

A high transmittance passband from the UV to about 6 micrometers. And, like quartz, sapphire "turns on" again in the far infrared — from beyond 100 micrometers but with a lower transmittance than quartz. Sapphire has exceptional chemical resistance and resistance to scratching.

KRS-5 (-9)

Also known as thallium bromiodide, this material has high and flat transmittance from 0.6 (visible yellow) to 35 micrometers. Actual transmittance extends to 60 micrometers but decreases steadily beyond 35. Since 35 micrometers corresponds to the wavelength of maximum energy of a blackbody at -190C, the KRS-5 filter affords great range in thermal instruments as well as in chemical analysis.

(Protection of electronics from visible light, as mentioned for quartz, also apply to the -4, and -9 filters)

Fire Filters

ELTEC has filters with high transmission at the carbon dioxide absorption/emission band of 4.35 micrometers. Atmospheric CO₂ attenuates energy in this band from the sun and distant infrared sources. This leaves the 4.35 band free for detection of nearby flame flicker (given only slight attenuation in a short distance). ELTEC's -23 filter is especially designed for this application having enough spectral breadth to accommodate wavelength shifts caused by angle of incidence and filter temperature. Moreover, the -23 filter is on a sapphire substrate and completely blocks all wavelengths longer than 6 micrometers. ELTEC's -12 filter has almost identical bandpass characteristics to the -23 filter except that it is on a germanium substrate. The -12 filter is used where there is a sapphire optical element in the system anyway and the long wave blocking is not needed. Note: Although the -12 offers electrostatic shielding, its bandpass opens up again after 6 micrometers. The -43 filter is a

Available Configuration of Pyroelectric Sensing Elements

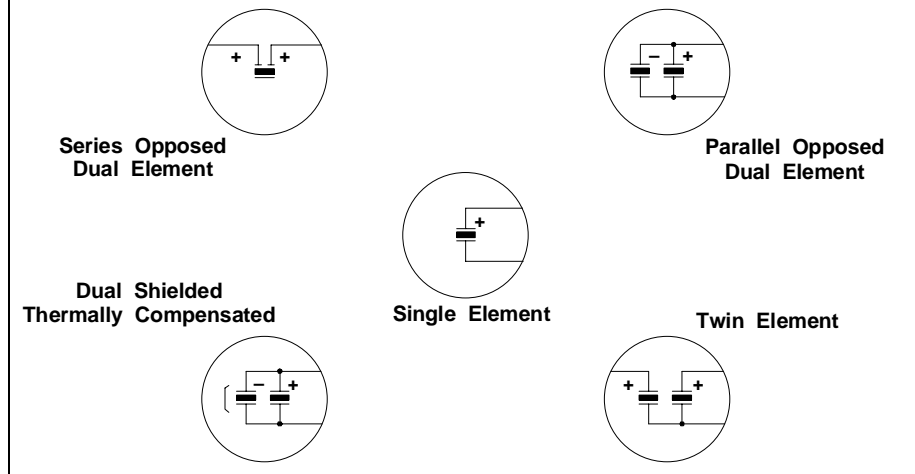

very narrow-band fire or CO₂ filter (on sapphire).

Gas Analysis CO₂ (4.268 μ m)(-113) & Broadband (-32)

Applications for gas analysis usually require narrow band filters such as one centered at 4.268 micrometers for carbon dioxide. Yet, a more common option for instrumentation is to obtain a broad bandpass filter (1.5 to 5 μ m) with linear, high transmission for the detector and use specific optical filters in revolving wheels or other configurations. This latter approach simplifies detector selection and stocking and can simplify filter procurement in that the suitability for inclusion in a detector is no longer a consideration. On the other hand, volume production or the use of expensive filters is made more economical by inclusion in the detector because the detector filter is only 5mm square and a given area of filter material is more efficiently used. Note that kerf loss, chipping or other factors affecting yield must be considered when calculating the economies of dicing a filter blank.

Calcium Fluoride (-27)

This material is useful from the sharp cutoff in the ultraviolet below 0.125 micrometers through the mid-infrared of the spectrum. It has high and flat transmission in all regions making it suitable for instrumentation applications. It is especially useful in the ultraviolet (but can sustain some transmission loss from radiation in prolonged high-altitude or space environment).

Barium Fluoride (-42)

Excellent transmission from the ultraviolet through long wave infrared. Excellent material for laboratory instruments. A thinner version (-398), is avail-

able where longer wavelength transmission is a necessity.

Zinc Selenide (-49)

Zinc selenide (-49) is an excellent material with flat transmission from visible yellow to 15 micrometers. It has much better environmental stability than barium fluoride. It is the preferred material for carbon dioxide lasers at 10.6 micrometers due to extremely small internal absorption. High usage means that window material is almost always quickly available. Uncoated transmission is 70% (index of refraction $n = 2.4$).

(Blocking the electronics from visible light is required for the -27, -42, -49, and -398 filters)

2. The Sensing Element

The sensing element of an ELTEC pyroelectric detector is a thin wafer of lithium tantalate crystal with electrodes on both faces. The material has a Curie point of 610°C, which means it remains pyroelectric below that temperature. Although the detectors are not rated for operation to 610°C, the high Curie point gives a substantial margin of protection because a thin wafer can heat up fast in response to an intense pulse of incident radiation.

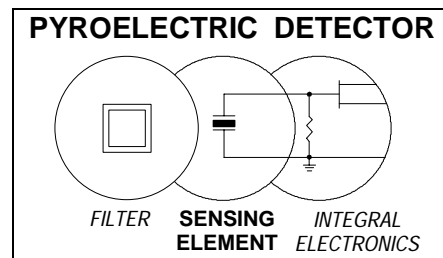

As pyroelectric technology has advanced, different sensing elements have

been developed to meet specific requirements. The **single** element has the highest normalized sensitivity (D^*) and lowest noise. **Dual elements** have two separate elements connected in either series or parallel opposed configuration so that extraneous signals generated in response to ambient temperature changes or rapid gross changes in the field of view will tend to be self-cancelling. Note that the dual is only useful in combination with faceted mirrors, segmented lenses, or any other optical arrangement that gives each element a different field of view. Properly used, the dual will give a sequence of positive and negative signals in response to an object or person traveling across the field of view (as in intruder alarms).

A **series opposed** dual generally has two separate sensing elements on a single crystal (two electrodes deposited on the top). These sensing elements are series opposed with the common bottom electrode electrically "floating".

A **parallel opposed** dual has two physically separate sensing crystals connected parallel opposed. A distinct advantage of this design is that "crosstalk" between elements at low frequencies is eliminated.

Given identical sensing crystals, the series opposed dual detector would have a higher output than the parallel opposed unit but with twice the noise. As regards the real figure of merit, the signal-to-noise ratio, the parallel opposed device leads by a factor of 2:1. Note: The parallel opposed design is recommended for most applications.

A **twin channel** detector has two sensing elements but, unlike the duals, outputs the channels individually. This approach is chosen for one or more of the following reasons: (a) Whereas the minimum common-mode rejection ratio of a series or parallel opposed detector is 5:1 (dependent on crystal or sensing element matching), the twin channel detector allows for external electronic matching for any common mode rejection desired; (b) Where direction of a person or object passing across the detector's view is sought (if the right crystal responds before the left, then movement is from the right to left). Note: The regular duals could be used to determine direction by keying-in to the polarity sequence of the pulses — but caution is advised because if the background changes from cooler than the object to warmer than the object, then the polarity of the pulses will switch; (c) The twin channel detector can be used with one of the two channels being used for redundancy check or backup.

The **dual-shielded** (thermally compensated) is useful in applications where the detector cannot be thoroughly isolated or insulated from rapid ambient thermal changes (sources of secondary radiation to the sensing element).

The **laser** crystal is like the single element except that it is heat sunk (not suspended) so it can tolerate much greater incident power. Also, the crystal is larger. Being heat sunk, the crystal thermalizes faster and consequently has less low frequency response. However, high speed laser pulsing or modulation seldom require anything but high frequency response.

Sensing element **arrays** consist of multiple crystals or sensing areas in close proximity. Since the selection of a particular array geometry depends on specific application requirements, all performance characteristics and costs must be carefully evaluated before a choice is made.

The pyroelectric sensing element is a self-generating device. If the power of the incident radiation is great enough (as in laser detection), no additional electronics may be needed to produce a useable output signal. However, this is seldom the case because the input radiation energy is usually low and the corresponding signal is at a high impedance level.

Thus to produce a more practical low-impedance voltage signal, practical electronics are packaged within most pyroelectric detectors. Naturally, the impedance conversion can be accomplished outside the detector, but most users choose integral electronics for reasons of convenience, reliability, shielding and cost.

The integral electronics usually consist of a voltage follower or current mode amplifier.

3. Selecting Integral Electronics

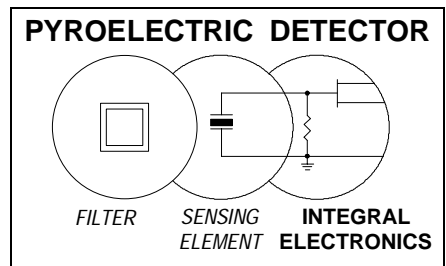
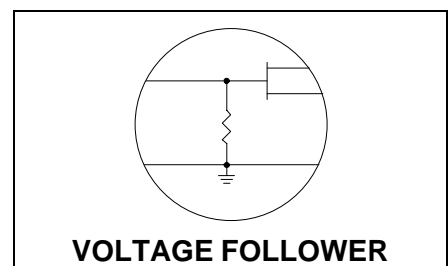

Detectors with a **voltage follower** offer a low output impedance and a high signal-to-noise ratio. The units are composed of a sensing element, an ELTEC thick-film high megohm load resistor and a field effect transistor. The thermal time constant of the crystal establishes the potential low frequency response. This thermal limit in conjunction with the effective

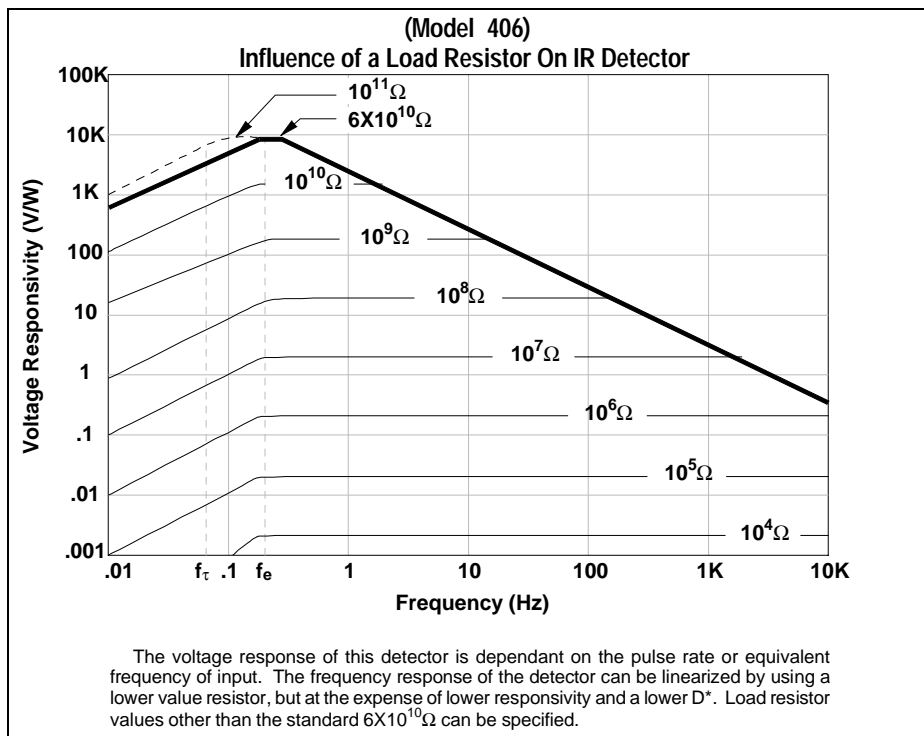

capacitance of the sensing element (including stray) and the high megohm load resistor determine the detector's frequency response. As the sample curve shows, responsivity decreases as load resistors are chosen to extend flat response.

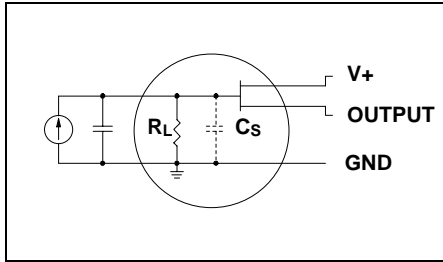

Note: The emphasis on low frequency response in the curve is important. Pyroelectric detectors are often used to detect motion at a distance. Since the detector responds to a temperature change in its field of view, an object crossing through the field of view rapidly at a distance may equate to relatively slow radians/seconds at the detector. Thus, the high responsivity in the region from 0.08 to 4.0 Hz is a special benefit of pyroelectrics because objects at a distance may occupy only a small fraction of the field of view and present a small optical power change to the detector.

The External Source Resistor

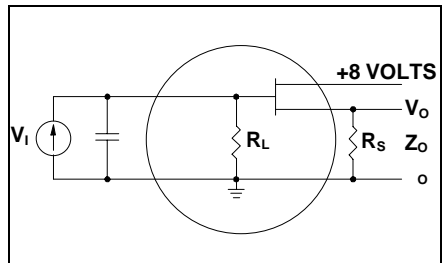

With the **voltage follower**, the gain of internal FET (and responsivity and noise as well) is determined by the external source resistor. For good responsivity and low noise, a resistor of 100K to 1 megohm is recommended. But in many applications, to match subsequent bipolar amplifier stages and to achieve good RF immunity, a lower value is used. The source resistor should not be less than 47K or any value low enough to allow power dissipation of the internal FET to exceed 1mW ... which would produce low frequency noise by creating warm air turbulence inside the detector.

The gain of the voltage follower is:

$$A = \frac{G_m R_s}{1 + G_m R_s}$$

where A = gain;

G_m = transconductance of FET at operating point;

R_s = value of source resistor

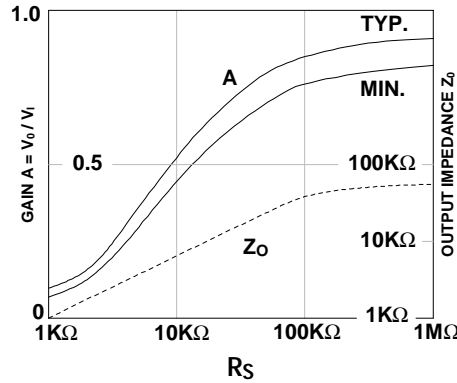

Power Supply for Voltage Followers

A 5 to 15 volt power supply is required for operation of a detector with a voltage follower. The supply should be well regulated. Since R-C combinations are not effective at frequencies below 1 Hz, active (usually integrated) regulators must be used. The voltage follower draws less than 20 μ A, so a battery is practical for experimentation and testing. However, if the battery is also used to activate a relay or other equipment, the power supply should have adequate decoupling.

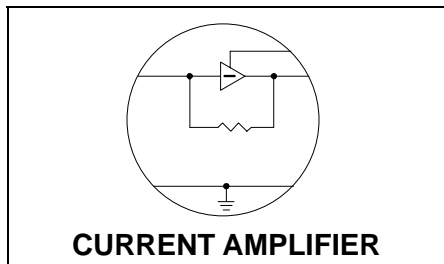

Detectors with a **current mode amplifier** have very high voltage responsivity. In fact, the signal strength is often great enough to eliminate the need for further amplification. However, in applications with low level inputs or demanding signal-to-noise requirements, the current amplifier should not be chosen.

The signal is not frequency dependent and that characteristic recommends it for many industrial control applications where the target objects appear at the

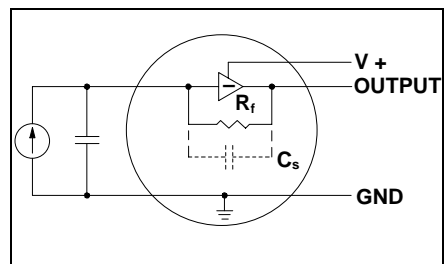

same distance but at diverse speeds. The gain is dependent on the feedback resistor, R_f . Frequency response is limited by the low pass filter R_f , C_s .

Other Integral Electronics

In addition to source follower and current mode amplifier electronics, ELTEC supplies devices with a source follower and integrated gain stage as well as a detector with both follower and current mode electronics. If your particular ap-

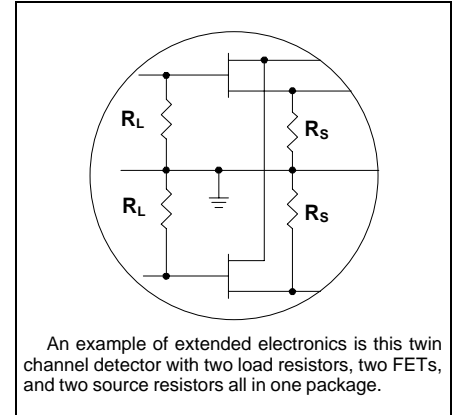

An example of extended electronics is this twin channel detector with two load resistors, two FETs, and two source resistors all in one package.

Thermal Isolation

Detectors, especially those with single sensing elements, are sensitive to rapid temperature changes. Even the dual element detectors which have a high degree (minimum factor of 5) of common mode rejection are subject to transient sensitivity when detecting low signal levels. Thus, some form of isolation may be necessary.

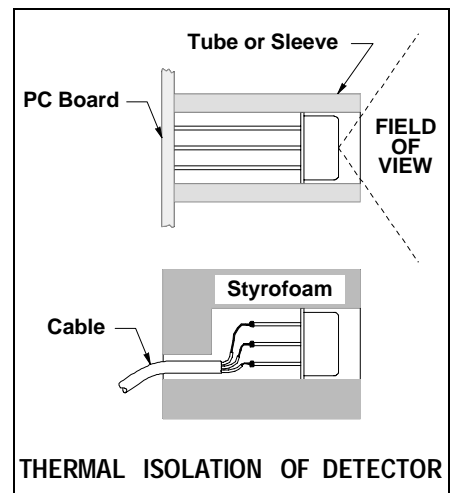

First, the instrument or device using the detector should have a completely closed housing - with plastic or laminated metal

sheeting being the materials of choice. And a window of polyethylene film or germanium (depending on operating wavelength) will protect the detector from air drafts.

Handling and Assembly

Overvoltage protection: Although junction FETs are used, it is recommended that in production assembly, the detectors be treated as MOS devices and protected from electrostatic charges. With current mode detectors with integral amplifiers, it is important to see that the devices are not subjected to reversal of supply voltage polarity.

Thermal Shock: Most infrared detectors are susceptible to damage from thermal shock. Although the storage range is typically -55° to 125°C (filter dependent), the **rate of temperature change** should be kept below 50C°/minute. Whenever possible, the detectors should be stored in covered containers in a cool environment.

Mounting: Avoid mechanical stresses on case and leads.

Soldering: Use minimum heat and use a heat sink between case and leads. Leave a minimum of about 1/4 inch or 6mm. **Do not machine solder.**

Filters: Advise production workers not to touch filters. Lint, dust, or fingerprints can usually be removed simply by rubbing with a cotton swab. If a cleaning solvent is needed, alcohol will suffice, except for the -9, which scratches easily and should not be touched.

Maximizing S/N

Noise, as a resolution or lower detectability limit, is not established simply by the detector and its internal circuit. Other sources to watch for are:

- Thermal fluctuations in the field of view of the detector (due to turbulence and variations in the atmosphere) and to a statistical deviation of photon emission from the source — which is to say the actual resolution is background limited.
- Warm air drafts on the detector case from heat dissipating components near the detector or improper sealing of the enclosure.
- RF, power line interference and other sources of EMI.
- Subsequent amplification or signal conditioning stage.

- The power supply.
- Components such as high resistance film resistors and electrolytic capacitors (the leakage current has a low frequency noise component).
- Mechanical contacts and weak solder joints.
- Microphonics or vibration (which can be **verified** by operating an accelerometer or microphone adjacent to the detector and **minimized** by acoustic or vibration isolation).
- These noises should be considered carefully when the information signal is below 1mV for a voltage follower detector and below 20mV for a current mode detector. Moreover, the noise mechanism at 0.1Hz may be completely different from that at 1KHz.

System Summary

The real decisions in "choosing and using" a pyroelectric detector are dependent on two considerations: (1) What are you looking at, and (2) what do you want done?

First, consider what you are looking at as a target (even though infrared is a passive technology). It follows that the closer the target, the greater the energy to the detector. The higher the temperature, the greater the radiated energy. The higher the emissivity (a black vs. polished aluminum object), the greater the energy emitted.

The faster the object moves through the detector's field of view, the greater the power change sensed by the detector - but the need for higher frequency response is required.

The temperature range determines the filter selection. The environment and some optics considerations determine the crystal selection. The power to the element ... and the required signal-to-noise ratio to the signal conditioning to get the job done determines the integral electronics.

Emissivity

Emissivity is very important in the practical application of infrared technology to objects. A black car heats up in the sun faster than a white car. And if one object absorbs radiation better than another, it also will emit radiation better. A perfect emitter/absorber is called a blackbody and has an "emissivity" of 1.00. A poor emitter/absorber, like the metallized suits

worn by firefighters may have an emissivity of perhaps 0.05 for protection from intense radiated heat. In short, the heat radiated by an object at a given temperature is directly proportional to its emissivity.

The practical implications: Human skin (all races) has an emissivity of 0.98, very close to a blackbody. If a person walks past a painted wall (emissivity of 0.90) which just happens to be the exact same temperature as the aforementioned person, he (or she) will radiate slightly more energy than an equal area of the wall. In this instance, the differences in emissivities are utilized in the operation of a passive infrared intruder alarm.

EMISSION TABLE (TYPICAL)

Taken From Various Source Material.
Low Temperature Emissivities
Perpendicular To Surface

MATERIAL	EMISSION
Blackbody (ideal)	1.00
Aluminum	
polished	0.05
heavy anodized	0.70
sheet	0.10
Brass	
polished	0.03
rough surface	0.20
tarnished	0.60
Brick	0.90
Carbon	
pure powder	0.95
Chromium	0.30
Cloth (cotton)	0.80
Concrete	0.90
Copper	
polished	0.05
tarnished	0.80
Glass (polished)	0.90
Gold (polished)	0.02
Iron & Steel	
polished	0.10 to 0.20
rusted	0.70
Nickel	
polished	0.05
oxidized	0.40
Oil	0.80
Painted Surface (typical)	0.90
Paper	0.70 to 0.90
Plaster	0.90
Sand	0.80 to 0.90
Silver (polished)	0.03
Skin (human)	0.98
Soil	0.90
Stainless Steel	
buffed	0.20
oxidized	0.80
Tin Plate	0.10
Water	
pure	0.96
ice	0.96
Snow	0.85
Wood	0.90

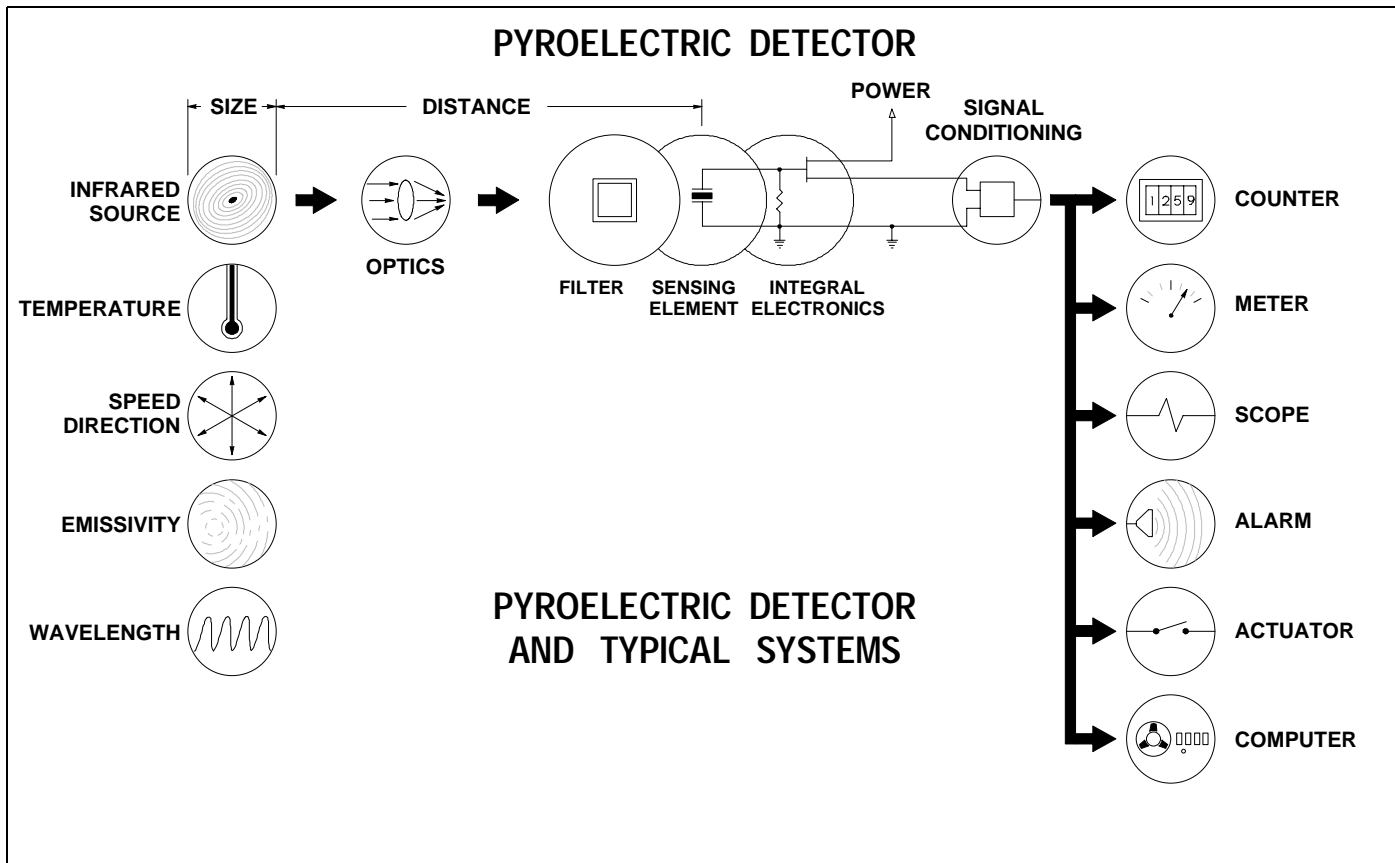

In a manufacturing operation, the difference in emissivity between a properly coated product and one inadvertently uncoated can be used for automated quality control to eject the uncoated object from the line. Note: Sometimes a shiny object with low emissivity may appear to be radiating more power than its temperature would produce. This can occur if the shiny object reflects energy from a nearby object at a higher temperature.

The table of emissivities on Page 101-7 is offered as a rough guide to what might

be expected in practice. Since emissivity is strictly a surface phenomenon, finish or oxide buildup or grit and grime or almost anything else might change values substantially. Moreover, emissivity can be wavelength dependent and temperature dependent. An approximate reference blackbody can be created in an object or material by drilling a hole five times or more greater in depth than diameter.

In this ELTEC data note, we've tried to include helpful information and useful tips. Often a specific application is straight for-

ward ... and some are quite involved. If we have not answered your questions, consult other ELTEC literature or a pyroelectric specialist at our headquarters in Daytona Beach, Florida.

We have not referenced specific products in this bulletin because new products are frequently introduced and ELTEC is continually advancing pyroelectric technology. Thus, we suggest you consult current product literature. In addition, custom detectors are available to meet your requirements.

Although every effort has been made to insure the accuracy of information, ELTEC assumes no responsibility for inadvertent errors. Publication of this information does not imply any authority or license for its use nor for any infringement of patents or rights of others which may result from its use.



Worldwide Eltec Product Distribution and Free Technical Support:
Silverlight Ltd. Glaernischstr. 59, CH-8712 Staefa, Switzerland
 Tel.+41 44 926 4362 Fax +41 44 926 6131 info@silverlight.ch
 Online Product Orders and Datasheet Library on <http://www.eltec.ch>